

Hydraulikschläuche (nach Norm)

Geflechtschläuche (PN-Armaturen)



Spiralschläuche (PA-Armaturen, Interlock)



Niederdruckschläuche



Thermoplast-Hochdruckschläuche

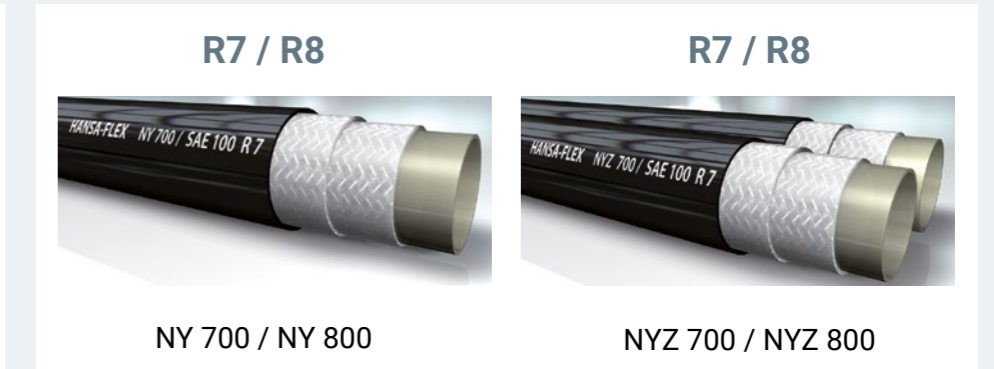

Hydraulikschläuche (für besondere Anwendungen)

Geflechtschlauch



Saugschlauch



Hohe Temperaturbeständigkeit



Thermoplast-Hochdruckschläuche



RAIL-Schläuche (EN 45545-2)

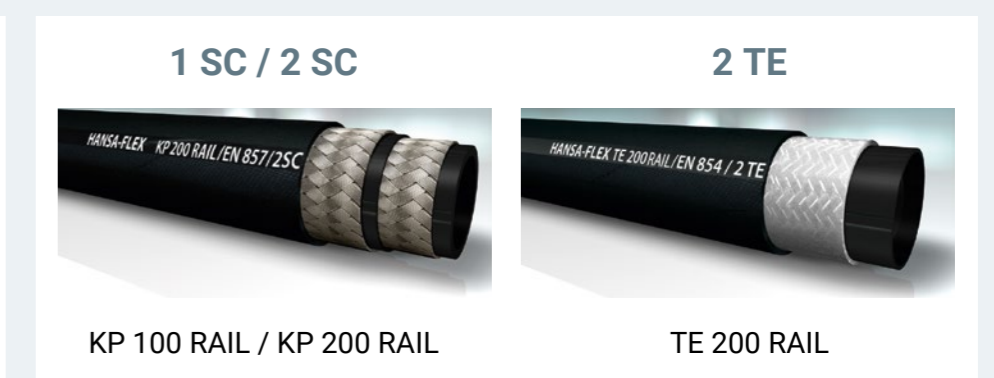

Schlaucharmaturen

Metrisch (ISO 8434-1)



JIC (ISO 8434-2)

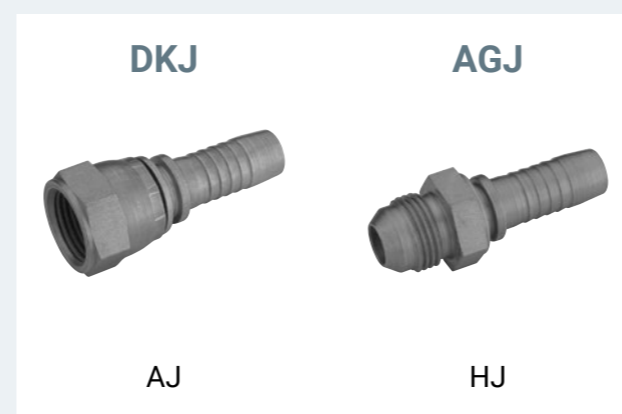

Zubehör

Hitzeschutz



Schlauchbündelung



UN/UNF (ISO 8434-3)

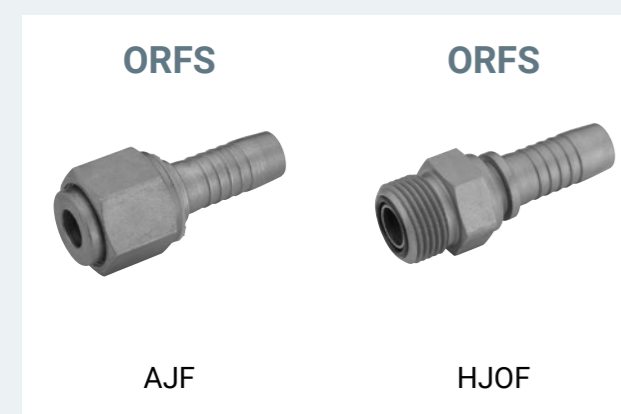

BSP (ISO 8434-6)

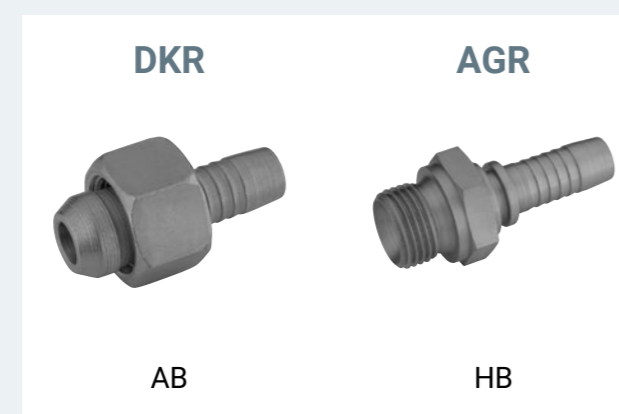

Flansche (SAE J518)



Scheuerschutz

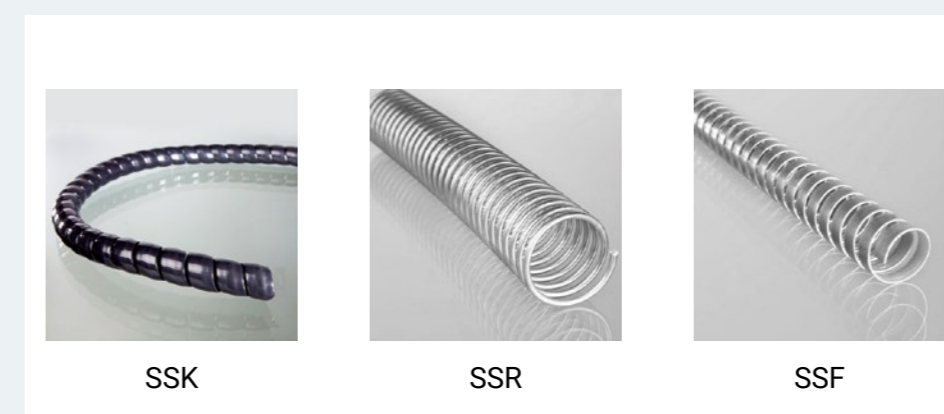

Knickschutz

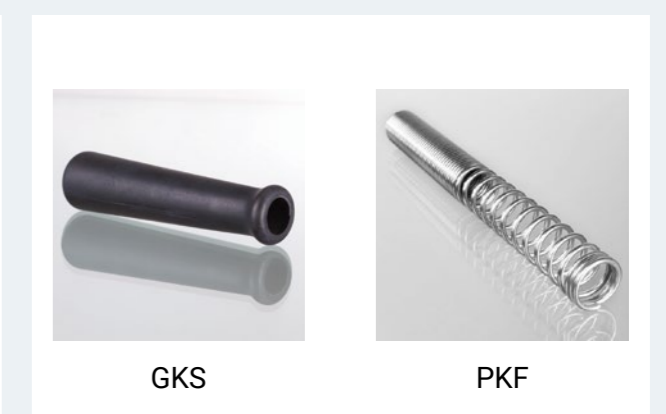

Ringaugen (DIN 7642)

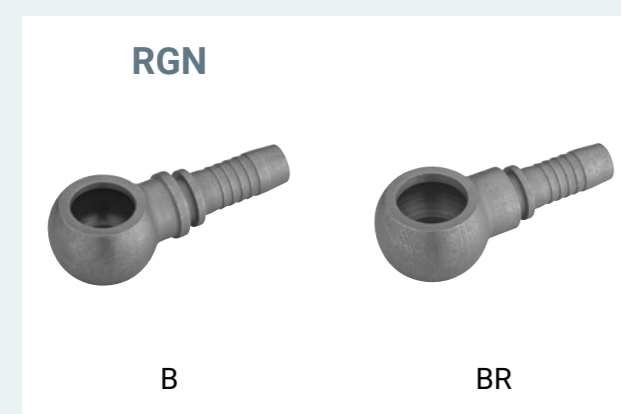

NPT (SAE J514)



Steckschalen-Klemmverbindung (SSKV)



Sicherheitstechnik

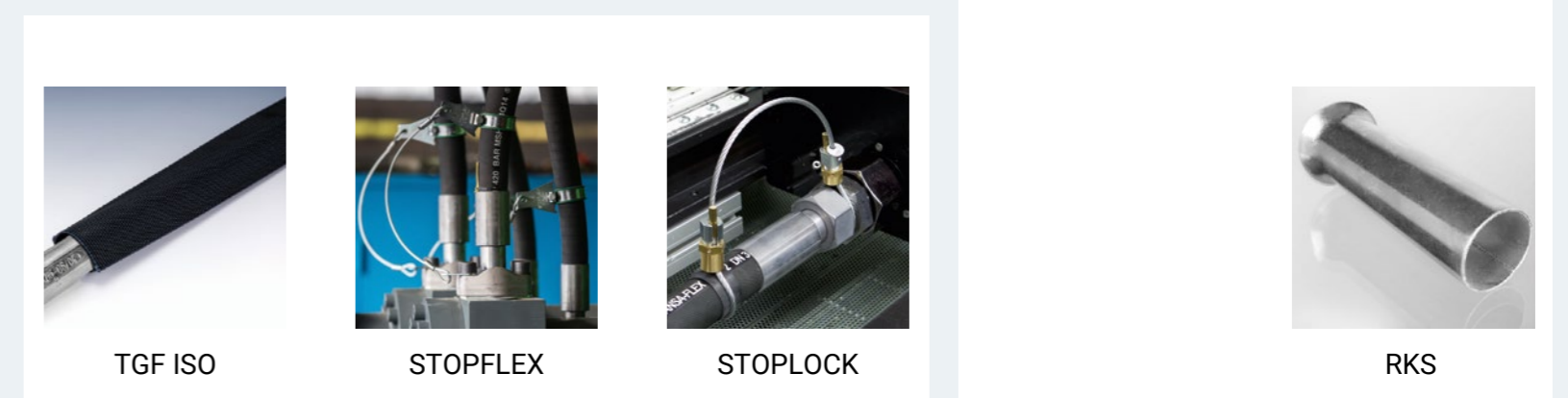

Technische Informationen

	Geflechtschläuche (PN-Armaturen)						Spiralschläuche (PA-Armaturen)					
	Nichtschälvariante			Schälvariante			Interlock, mit Ausreißsicherung					
Schlauch NW	03	04	06	08	10	13	16	20	25	32	40	50
DN		5	6	8	10	12	16	19	25	31	38	51
Size		3	4	5	6	8	10	12	16	20	24	32
Zoll		3/16"	1/4"	5/16"	3/8"	1/2"	5/8"	3/4"	1"	1 1/4"	1 1/2"	2"

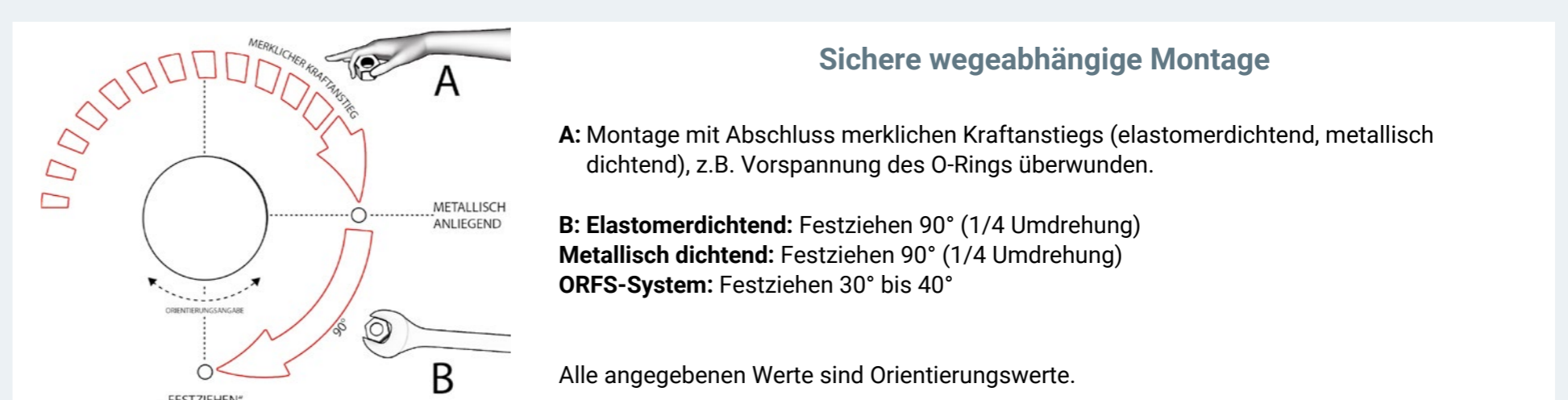
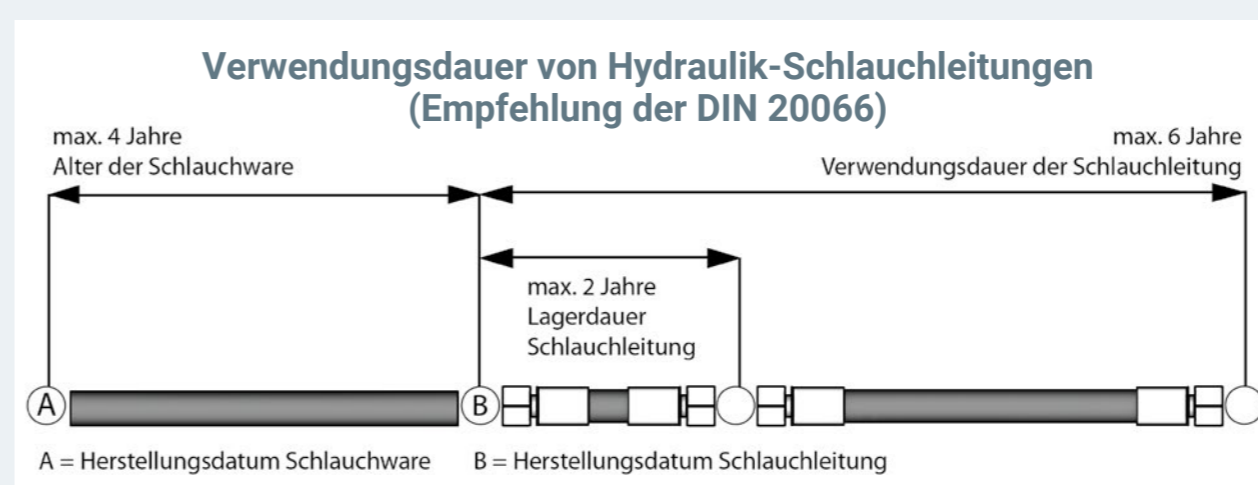
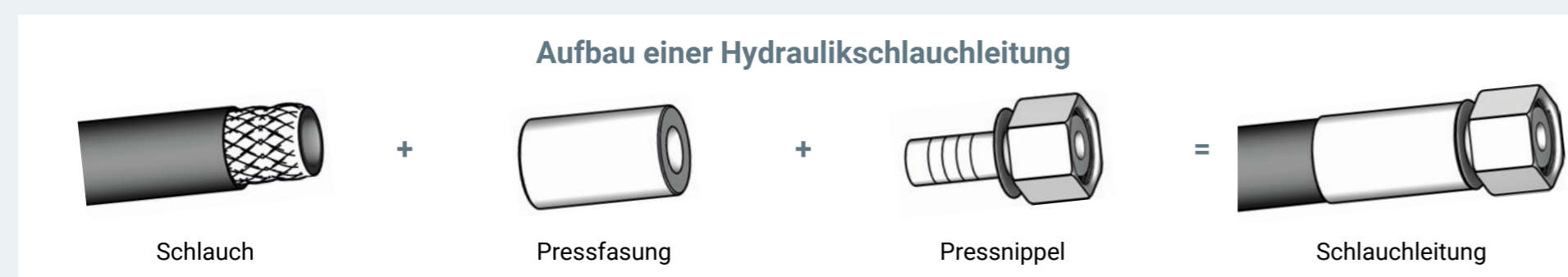

Die hier dargestellten Produkte sind lediglich ein Auszug aus unserem Komplettangebot. Weitere Produkte finden Sie unter www.hansa-flex.com/katalog